

TOPFORM SPEC - samonośny szalunek tracony stosowany przy wykonywaniu nadproży o specjalnych kształtach.

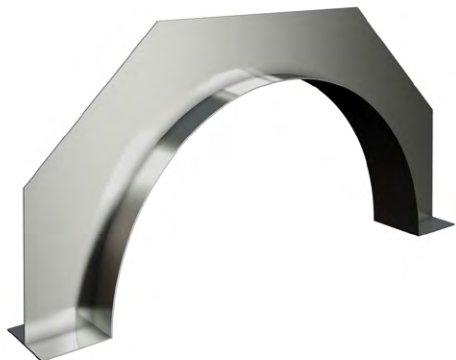

TOPFORM SPEC ELIPTICAL

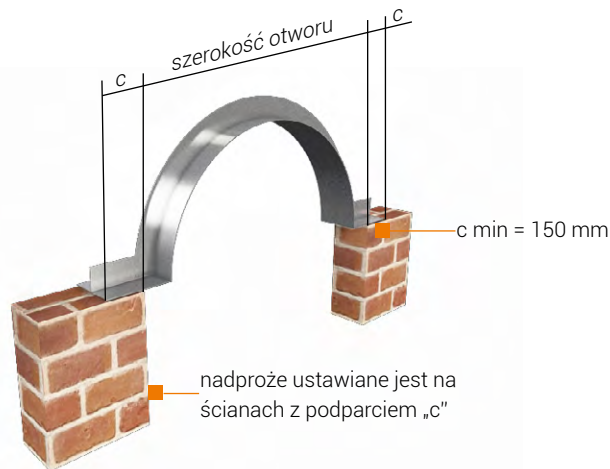

SZALOWANIE NADPROŻA

WERSJE KONSTRUKCYJNE

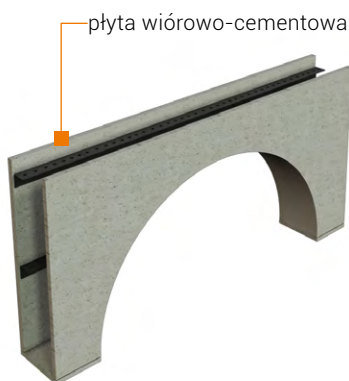

NADPROŻE ŻELBETOWE

Po zamontowaniu na ścianach zalewany jest betonem.



NADPROŻE STALOWE

Po zamontowaniu na ścianach murowany jest materiałem konstrukcyjnym ścian.

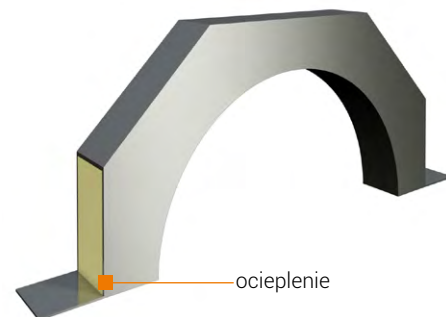

NADPROŻE STALOWE Z OCIEPLENIEM

Po zamontowaniu na ścianach naklejane są płytki ceglane.

Nadproża wykonywane są wg projektów indywidualnych, uwzględniając:

- konstrukcję ściany
- szerokość otworu
- dopuszczalne obciążenie robocze

Na zamontowane nadproże naklejane są, specjalnie przycięte okładziny z cegły idealnie imitujące mur ceglany.

INFORMACJE TECHNICZNE

Stosowany materiał wersja 1	plyta wiórowo-cementowa
Stosowany materiał wersja 2 i 3	blacha stalowa
Typ blachy stalowej	DX51D
Grubości standardowe blachy	1,6; 2,0; 2,2; 2,5 mm
Rodzaj ocynku	Z 275
Zabezpieczenie ciętych krawędzi	malowanie antykorozyjne
Materiał izolacyjny w wersji 3	wełna mineralna lub pianka

TOPFORM SPEC APEX

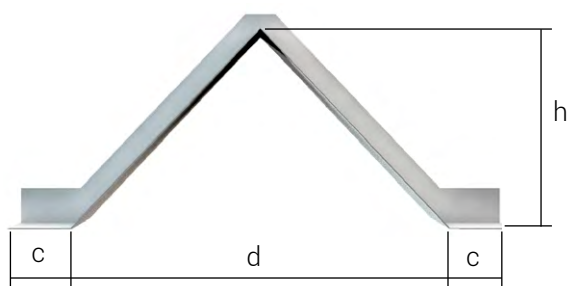

WYMIARY	NR KAT. 950-...
a =	[mm]
b =	[mm]
c =	[mm]
d =	[mm]
h =	[mm]

TOPFORM SPEC CIRCULAR

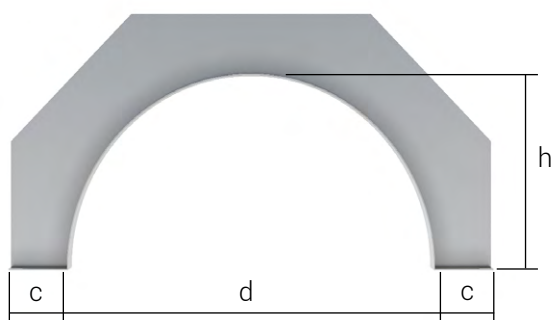

WYMIARY	NR KAT. 951-...
a =	[mm]
b =	[mm]
c =	[mm]
d =	[mm]
h =	[mm]

TOPFORM SPEC ELIPTICAL

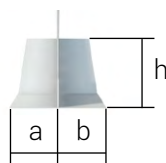
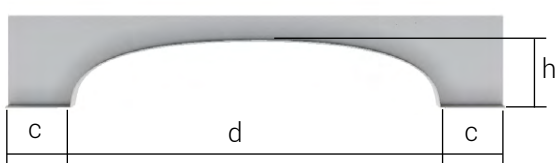

WYMIARY	NR KAT. 952-...
a =	[mm]
b =	[mm]
c =	[mm]
d =	[mm]
h =	[mm]

TOPFORM SPEC VENETIAN

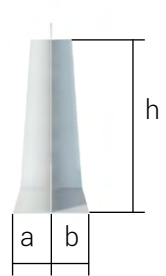
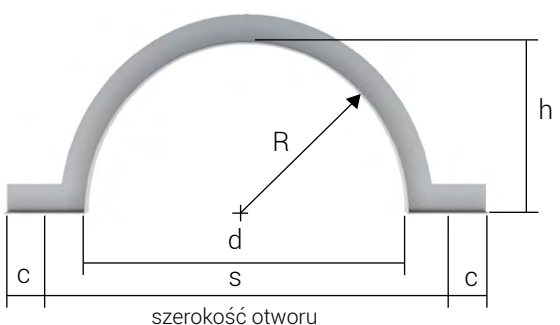

WYMIARY	NR KAT. 953-...
a =	[mm]
b =	[mm]
c =	[mm]
d =	[mm]
s =	[mm]
h =	[mm]
R =	[mm]

TOPFORM SPEC CLUBS

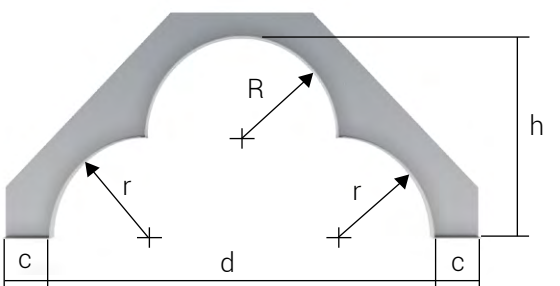

WYMIARY	NR KAT. 954-...
a =	[mm]
b =	[mm]
c =	[mm]
d =	[mm]
h =	[mm]
R =	[mm]
r =	[mm]

TOPFORM SPEC PARABOLIC

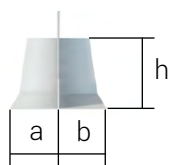
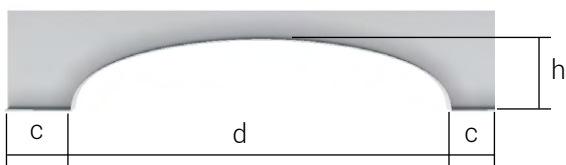

WYMIARY	NR KAT. 956-...
a =	[mm]
b =	[mm]
c =	[mm]
d =	[mm]
h =	[mm]

TOPFORM SPEC GOTHIC

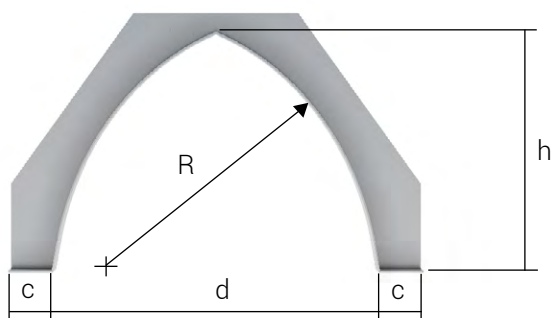

WYMIARY	NR KAT. 957-...
a =	[mm]
b =	[mm]
c =	[mm]
d =	[mm]
h =	[mm]
R =	[mm]

TOPFORM SPEC EYE

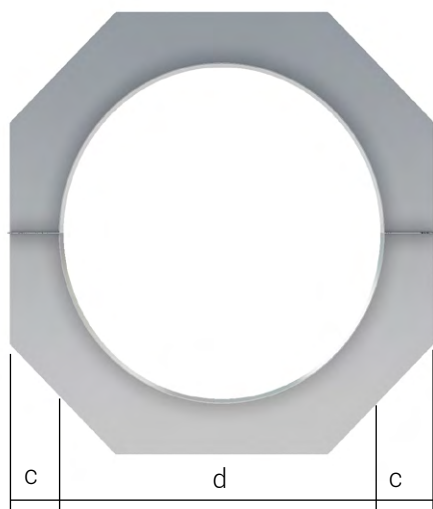

WYMIARY	NR KAT. 958-...
a =	[mm]
b =	[mm]
c =	[mm]
d =	[mm]

TOPFORM SPEC SEGMENTAL

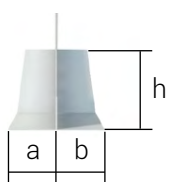
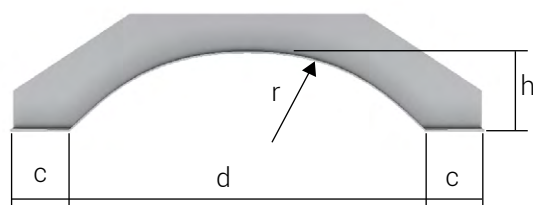

WYMIARY	NR KAT. 959-...
a =	[mm]
b =	[mm]
c =	[mm]
d =	[mm]
h =	[mm]
r =	[mm]

